

Wood & aluminum windows



# Aluminum clad wood window overview

Wheaterproof outside, cosy inside





# Contents

UNILUX opening up perspectives	04
All good things come in sixes: Brand advantages of UNILUX	06
Advantages of aluminum clad wood	08
UNILUX aluminum clad wood windows	10
UNILUX aluminum clad wood windows: Passive house stars	11
UNILUX aluminum clad wood windows: DesignLine Privacy	12
UNILUX aluminum clad wood window frames for renovation	14
UNILUX basic benefits and UNILUX optional benefits	16
Unlimited variety of shapes, shades and materials	18
Handles: Design and safety	20
Glass competence and privacy	22
Impressive glass surfaces. Slim profiles.	24
Full glass corner OpenView	26
Lift/Slide system HS	28
Bi-Fold system aluminum clad wood	30
Facade system FineLine	32
Large-scale door JumboLine	34
References	36
The reliability of a big name	38







UNILUX

# One brand. One promise.

The only thing modern-day windows have in common with their “ancestors” is their name. Good carpentry work and appearance alone is no longer enough, because energy efficiency, safety, and functionality standards have increased dramatically to meet today’s customer needs.

That’s why all UNILUX aluminum clad wood products are inhouse developments, demonstrating an extraordinary degree of product intelligence and complex engineering.

**To ensure these masterpieces are not just available to a selected group of people, UNILUX produces them as series, enabling these unique aluminum clad wood products to be sold at prices which make top quality affordable.**

UNILUX opening up perspectives.



All good things come in sixes:

# The UNILUX brand advantages

## Brand advantage 1: Durability

Ever since its early days, UNILUX has always used the highest-quality materials. Down to the finest detail: instead of the inferior silicon, we use smooth glazing seals made from synthetic rubber. The high-quality workmanship and strict quality controls ensure you gain long-term enjoyment from your UNILUX window.

## Brand advantage 2: Freedom of design

Some things are a matter of taste. Thus, you can choose from our three designs - LivingLine, ModernLine and DesignLine. And that's just the beginning. Every one of those models can be customized. From the choice of wood to the coloring - all RAL colors for aluminum and special wood colors up to the handles. And let's not forget: a wide variety of window shapes (they don't have to be rectangular, after all) and muntins upon request in four different lines. Variety right from the factory.

## Brand advantage 3: Energy efficiency

UNILUX's solid construction style not only guarantees durability, but also helps save energy. In the standard version, each of our wood-aluminum windows has a „warm edge“ which forms the thermal separation between the glass panes. That provides better insulation values, more comfort in the vicinity of the window, and significantly less condensation in cold months. Heating costs can be further reduced in conjunction with a highly efficient triple-glazing.





### **Brand advantage 4: Safety**

Sometimes a window's job is not just to keep out wind and rain, but also uninvited guests. That's why all UNILUX locking parts are made from high-quality materials. Mushroom pins are also a standard feature of all our aluminum clad wood window fittings. For those who want even more security, we offer maximum protection with our SAFE packages.

Read more on page 21.

### **Brand advantage 5: Service**

UNILUX only works with expertly qualified window specialist retailers, located across the country with their own showrooms. Your regional UNILUX retailer will offer you detailed advice and assist you with your plans. It will also ensure prompt, correct installation, and will be available at any time if you have any service-related needs.

### **Brand advantage 6: Brand quality**

Since 1955, UNILUX's philosophy has been: Only products of uncompromising quality must leave the factory. This saw our company become a recognized quality leader over the decades. Anyone who pays heed to the UNILUX logo can be certain of always receiving a "Made in Germany"-branded product.







## Advantages of material mix

# Aluminum on the outside, pure wood on the inside – combined for generations

Wood creates comfort – it is a feel-good material. Aluminum on the other hand, is a robust protective shield against the elements. Together, they form an aluminum clad wood product which lasts generations without the need for continuous maintenance.

The wood interior does not require UV protection in the form of coloring pigments in the finish. It can be used in its natural form (transparent stain) thanks to the aluminum shell. The aluminum shield firmly encases the wood, protecting it from the elements while still giving room to expand and contract and cope perfectly with temperature fluctuations.

**UNILUX aluminum clad wood products:**  
the originals.



# Aluminum clad wood windows

## Discover diversity

No house is like any other. To ensure that you can design your home exactly the way you want it, we offer our 0.8 and 0.7 series of wood & aluminium windows in three different styles.

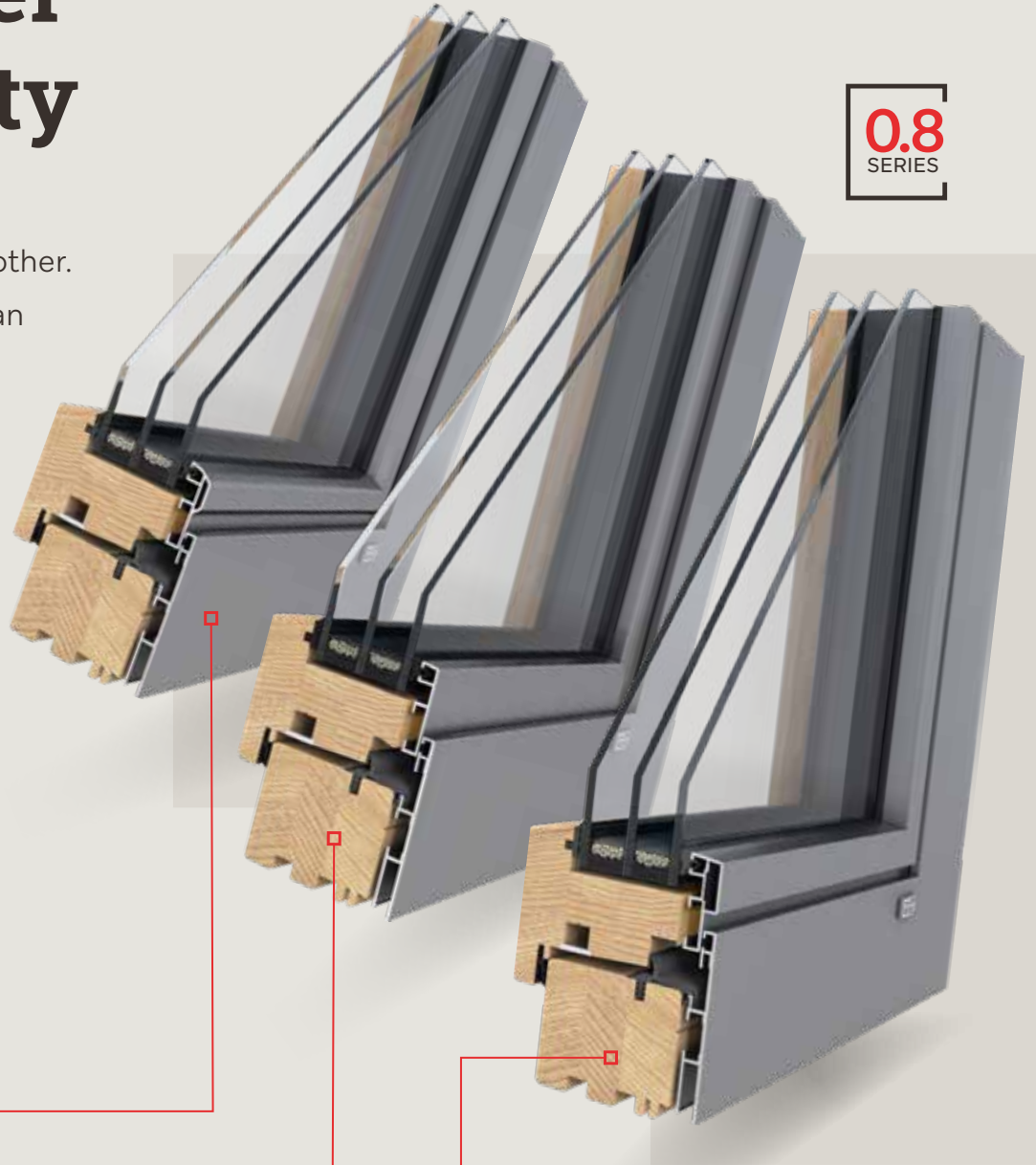

**Unilux LivingLine**

**Unilux ModernLine**

**Unilux DesignLine**



	Installation depth	Glass thickness
0.8 Series	78 mm	up to 52 mm
0.7 Series	78 mm	up to 52 mm

## Unilux LivingLine

Some things never need to change. The wood & aluminum windows in the LivingLine series are so discreet that they fit harmoniously into any traditional architecture, and are very attractive when renovating older buildings as well.

## Unilux ModernLine

Modern architectural classics were the inspiration. The wood & aluminum windows in the ModernLine range have no frills. With their clear, straight lines, they are ideal for contemporary homes and buildings with an urban flair.

## Unilux DesignLine

The attractive way to save on energy costs (heating or cooling). The DesignLine aluminum clad wood window range combines architectural elegance and state-of-the-art energy efficiency. Uncompromising in terms of aesthetics, it is designed for high-quality residential buildings and condominium buildings.



# Passive house Stars

The Passive House stands for healthy and comfortable living with high energy efficiency. As a premium manufacturer of wood-aluminum windows, UNILUX has adapted the development of its product range to meet these requirements, because our wood-aluminum windows allow you to achieve passive house standards.



**0.7**  
SERIES

### The core for more insulation

An additional insulating core in the window frame helps to achieve a better thermal insulation. In addition, the pine wood naturally provides a good insulation value. In this combination, the wood-aluminum windows can reach a  $U_w$ -value of 0.73. Thus, they can meet the strict criteria for passive house windows. This means that you automatically have to heat less.



$U_w$ -value

$U_g$ -value

Burglar-proofing

Soundproofing

up to 0,77 W/m<sup>2</sup>K

up to 0,5 W/m<sup>2</sup>K

up to Safe+++ / RC2

up to 47 dB

up to 0,71 W/m<sup>2</sup>K

up to 0,5 W/m<sup>2</sup>K

up to Safe+++

up to 47 dB



# Aluminum clad wood windows

## DesignLine Privacy

"My home is my castle." Just block the world out. Be undisturbed, footloose and fancy free. This is easy with the aluminum clad wood DesignLine Privacy window. Thanks to integrated blinds, you can create privacy at any time – even by remote control if you wish. Also save on energy compared to a roller-shutter or venetian blind box.

DesignLine Privacy

### Advantages on 4 levels

#### 1. Privacy

Discretion could not be more easily achieved. Nothing has to be built, mounted or improvised. The blinds move easily, via remote control if required.

#### 2. Peace and quiet

Three or even four glass panes mounted some distance from one another enable unrivalled sound-proofing. Test it for yourself and pull the blind up: You'll see the cars but won't hear them.

#### 3. Warmth

Roller-shutter or venetian-blind boxes are often energy guzzlers. Heat escapes and cold creeps in. DesignLine Privacy gets rid of this airlock. Since the blind is now part of the window, the boxes are no longer required.

#### 4. Freedom of design

The integrated blind – with your choice of color – offers you a wide range of possibilities. As you don't require shutters, curtains or separately mounted blinds, your freedom of design is greater than ever before.

Try out more comfort. As an option to the standard chain cord, the blinds integrated into many windows\* can now be operated by remote control from the comfort of your sofa, armchair or bed.





### Sleek appearance

No frills, no gadgets. The DesignLine models stand for clear, puristic lines. Timeless window design.









### Internal blind

The energy-efficient alternative to the box above the window. It can be easily adjusted to the sun's position via motor or chain. As it is located inside, it hardly gets dirty, either.



### Easy to clean

The blind sits in front of the insulated glass unit, making the rare cleaning sessions a piece of cake. Simply open the sash, clean it, and you're done!

					
Installation depth	Glass thickness	U <sub>w</sub> -value	U <sub>g</sub> -value	Burglar-proofing	Soundproofing
78 mm	up to 32 mm	up to 0,80 W/m <sup>2</sup> K	up to 0,5 W/m <sup>2</sup> K	up to RC2	up to 47 dB



## Aluminum clad wood windows frames for renovation

# The smart way to renovate windows

Window renovation can be so easy! Thanks to the renovation window frame from UNILUX, replacing obsolete windows is child's play. You don't even need to worry about plaster or wallpaper. Everything gets done cleanly and quickly.

Experienced installers manage that by simply removing the sashes of your old windows and cutting off the frame. Then they already have the groundwork laid for your new wood-aluminum window.

You can choose from all the many variants of a Design-Line window. And just like windows for new construction, you have all the different options for design available. For custom windows at lightning speed.

The decisive factor: The skill of installers matches the high quality of our windows. So you can be absolutely certain that your energy-saving DesignLine window with renovation window frames will have the same thermal insulation values as a DesignLine window in a new house. And plastering and wallpapering? They're just as much a thing of the past as masonry repair.

**The renovation window frame from UNILUX – new windows, without the stress.**



**0.8**  
SERIES

### **New windows, no muss, no fuss.**

Clean insertion into the old window frame leaves the masonry and stucco intact, and interior plaster and wallpaper aren't affected either. Even an existing window sill can be cleanly integrated.

The new window fits harmoniously into the existing window opening, from both the visual and technical points of view.

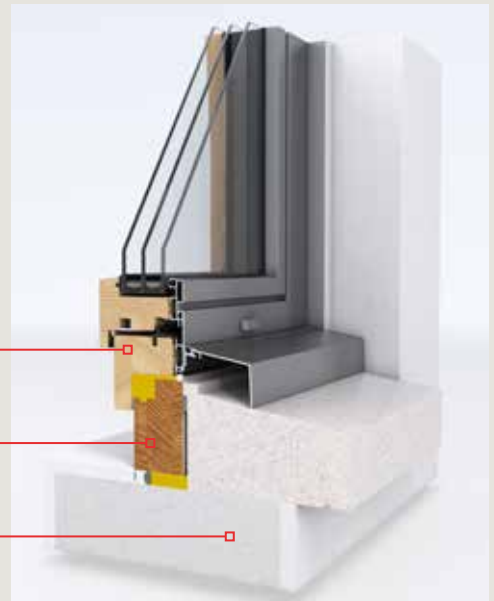

**New renovation window frame**

**Old window frame**

**Masonry and stucco**



**Clean**

The entire area is cleanly covered and taped before work begins. The old window sashes are removed, and the old frames cut off without leaving dust. They will be used as the foundation of the new window structure.

**Safe**

By stable anchoring into the frame and the masonry and by adding foam and insulation, our new windows aren't just visually attractive – they're also attractive when it comes to security and thermal insulation.

**Fast**

Once the new frame is inserted and anchored, the only thing left to do is simply to mount the new sashes. And then your room shines in a new light – without the mess, and without the stress.



Quality as a standard:

# the basic UNILUX advantages

As you know from buying cars, some models look cheap at first glance. But upon closer examination, you are incredulous at all the extras charged by the manufacturer.

That's not the case at UNILUX. Our basic features in themselves are so extensive, that there is often no need for accessories. Each of our standard aluminum clad wood windows has the following special features:



## [ Glazing seal

Silicon may be cheap, but it fades easily, is hard to clean, and susceptible to cracks and abrasion. UNILUX uses the better alternative: synthetic rubber, which is easy to clean, fade-resistant, long-lasting and hardly noticeable.



## [ Aluminum cladding slider couplings

Aluminum contracts or expands more than wood in cold or hot weather, creating tension on the frame. We prevent this from happening by mounting the aluminum cladding on slider couplings – similar to a rail system. This also ensures the wood is properly ventilated at all times.



## [ Superior-quality wood

Not all woods are the same. To guarantee a consistently high quality of materials, we use our own experienced wood purchasers, even in the most distant of supply countries. The same strict standards are applied during treatment – to ensure the wood has a long and healthy life.



## [ Embedded lock keepers

Impressive not only aesthetically, but also from a security perspective – due to being recessed compared to screwed-on locking parts. And the window frames are also easy to clean due to the fact that all the metal parts are recessed/embedded.



## [ Aluminum powder coating

"The exterior paint has chipped" is a phrase unfamiliar to UNILUX customers. Because our aluminum clad wood windows are made using aluminum powder coating, which has been tried and tested in the automotive industry. The result is highly robust paintwork able to withstand even the harshest of elements.



## [ Extra warmth: Triple glazing

Three panes are part of the standard fitting for UNILUX. This ensures improved thermal insulation and thus lower energy costs. Since the pane can have a thickness of 32 to 52 mm (1 1/4" to 2 1/16"), it can also be efficiently equipped with noise protection.

Extra perfect:

# the UNILUX optional advantages

Special circumstances require special solutions. That's why UNILUX offers exclusive added value when it comes to security, material protection and energy usage.

These additional benefits also give you the peace of mind of knowing you have the ultimate aluminum clad wood windows. Perfection, made by UNILUX.



## [ Added security: SAFE

In standard version, our windows and glazed doors already have secure mushroom-pin locks. For those who want even more security, we offer maximum protection with our SAFE packages. Choose between SAFE +, SAFE ++ and SAFE +++.



## [ Plus: Aneloxal coating

It's not just acid rain which can corrode metal. Salty sea air can also have aggressive, negative impacts up to 60 miles/100 kilometers inland – including on stainless steel. Pre-anodising, - the "aneloxal" process – effectively prevents corrosion. We are one of the very few manufacturers to use this form of coating at customers' requests, thereby ensuring UNILUX aluminum clad wood windows remain a symbol of durability, even in coastal areas.



## [ Glass competence

You can not only design UNILUX windows visually, our glass can also be completely customized to your needs. It's your choice: Noise protection, security, sun protection or a higher degree of thermal insulation - with UNILUX nothing is left to be desired.



## [ Wood-aluminum 0.7

Wood-aluminum windows from UNILUX already have a good thermal insulation value in their standard version. For all those who want a special insulation, we build an additional insulating core in the window frame. This makes your window passive house compatible.



# Endless variety of shapes

There are practically no limits when selecting the shape of your aluminum clad wood windows. Triangular or circular window? Sectional or semi-circular arch? With or without SDL or TDL bars? Your specialized UNILUX trade partner will show you what's possible.

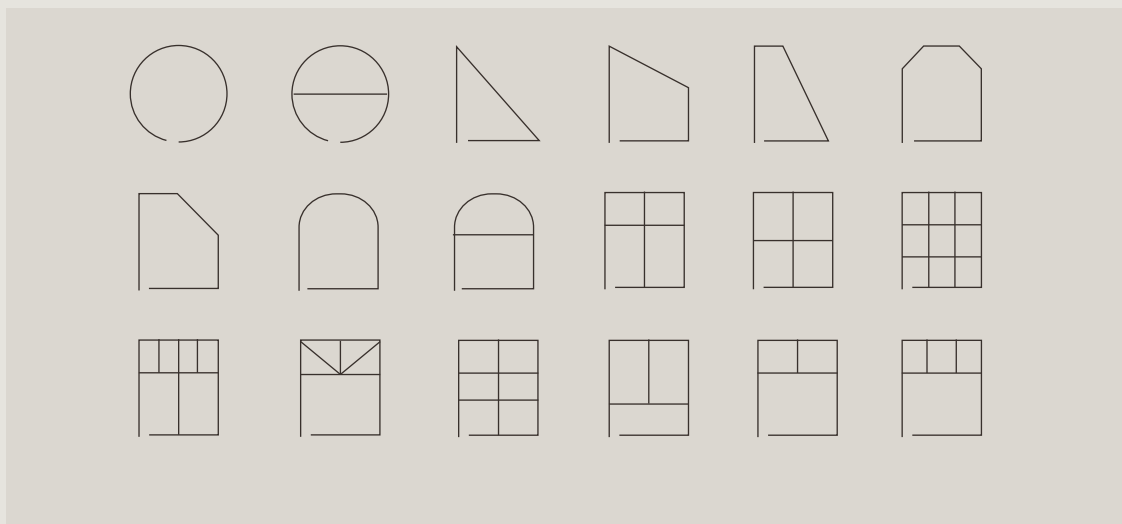

# Amazing colour freedom



How many different tastes are there? Around 2 million when it comes to wood and color. Because that's how many combination options you have for your individual UNILUX aluminum clad wood windows. Find out which wood species goes best with which color, and which pattern goes with the aluminum cladding.

For interior design (= the wood variety and wood coating) there are 4 wood varieties and 200 colors available (covering RAL colors and wood glaze tones). You have even more options for the exterior design (= the aluminum covering). Here, you can choose from over 2,100 colors or decors (RAL, NCS, DB/Eloxal and white pigment colors as well as wood decors).

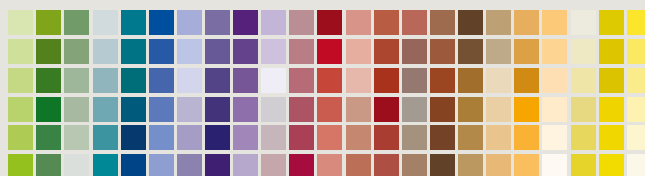

## Your world is colorful

Colors are an expression of personality and attitude towards life. Show off your taste and choose from a range of colors which leaves nothing to be desired.



Eukalyptus Grandis



Larch



Pine



Oak



## It's your choice

Even when it comes to wood colors, UNILUX always gives you the choice. Select from a wide variety of wood species, and make the most of the options for designing the wood's color scheme.

Choose from the following wood species: Pine, Oak, Larch and Eukalyptus Grandis, as well as 20 transparent or semi-transparent finishes.

## You love wood

Wood is a living material, so it's nice if you can incorporate it into your living space. UNILUX aluminum clad wood windows bring this vitality to your living room.



# A handle on design

Design you can grab: Every UNILUX handle is not only a solid piece of “Made in Germany” workmanship, but also a visual gem. A tool enabling you to express your taste and style.

Make an interior design statement with our modern window handles! Carefully selected, the right handle completes the ensemble: Window plus handle. It’s a little extra with a significant effect, a focal point that catches everyone’s eye.

## Aluminium handle

The all-purpose aluminium allrounder: This simple design is used to open and close a window and is suitable for every kind of UNILUX window. In addition to the standard version, it is also available with a locking button, or you can get a lockable version of it. You can order it in four classic colours.

 white  silver  steel colours  bronze

## Aluminium handles, blasted & anodised



The five aluminium models are

available in the following colours:

 black blasted anodised

 medium bronze blasted anodised



## Stainless steel handles

Our stainless steel window handles come in a range of sizes and shapes. The rounded L-Form version is available in stainless steel. We offer the angular K-Form version in stainless steel and black.

 stainless steel  black

To optimise the security of your windows, you can opt for K-Form stainless steel handles also with an actuation lock or for an RC2-tested version with lockable actuation lock.

The five aluminium models are available in the following designs:

- Window handle with actuation lock
- Window handle with RC actuation lock

# Added security

Protect your most valuable items. Burglars are risk-conscious people. They are quickly dissuaded once they realize the hurdles are too high. Thanks to sturdy profiles, anti-burglary fittings, lockable handles and special safety glass, UNILUX ensures that thieves think twice before attempting a burglary. Our windows and patio doors help to ward off suspicious characters.

## Safety levels

With the SAFE packages you reinforce the resistance of your windows against burglaries in three stages (+, ++ and +++). This ensures you are always on the safe side with your windows.

Of course for the highest security requirements we also offer the DIN EN-tested safety classes RC2 and RC2N. In this configuration, the UNILUX windows were tested intensively for you by neutral testing institutes.

## VSG, P2A + P4A safety glass

Don't most burglars simply break the window? Wrong! Very few thieves break the glass, because of the fear of noise and injury. Nevertheless, it can make sense to think about burglar-resistant glazing, for example:

- Laminated safety glass (LSG) with single or double PVB film
- Laminated safety glass (LSG) with four PVB film layers for impact-resistant Class P4A glazing

Both these types of glass include one or more PVB films between the panes. The films prevent the glass from breaking and make it much harder to destroy the glass.

Laminated safety glass (LSG) with single or double PVB film

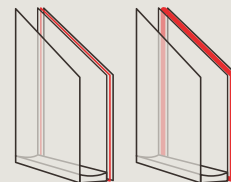

Laminated safety glass (LSG) with four PVB film layers for impact-resistant Class P4A glazing in accordance with DIN EN 356

	Standard <sup>1)</sup>	Safe+ <sup>1)</sup>	Safe++ <sup>1)</sup>	Safe+++ <sup>1)</sup>	RC2N <sup>1)</sup>	RC2 <sup>2)</sup>
<b>Locks</b>	Standard	4-corner <sup>2)</sup> safety locking	4-corner <sup>2)</sup> safety locking	RC2-compatible	RC2-compatible	RC2-compatible
<b>Handle</b>	Standard	locking button <sup>3)</sup>	lockable <sup>3)</sup>	lockable <sup>3)</sup>	lockable	lockable
<b>Drill protection</b>	-	-	✓ <sup>4)</sup>	✓ <sup>4)</sup>	✓	✓
<b>Tested glass connection<sup>5)</sup></b>	-	-	-	-	✓	✓
<b>Glass</b>	-	-	-	-	-	P4A

<sup>1)</sup> The locking elements may vary. The number and position of the locking points depends on the model and dimensions of the element. There are limited options for non-rectangular elements - <sup>2)</sup> In plastic windows: Locks suitable for Class RC1 elements - <sup>3)</sup> Deselectable handle - <sup>4)</sup> In plastic windows: For wide window sash with no drill protection - <sup>5)</sup> Pane bonding



# Glass-competence

UNILUX sets high standards in terms of glass, that is why every UNILUX window is fitted with 3-pane insulating glass as standard. But that alone is not enough for our engineers and developers. For all those who want more than just to design their windows, UNILUX offers various possibilities to upgrade their glass. However you decide, every UNILUX window is an example of groundbreaking glass competence.



## [ Noise protection

One of the important tasks of a home is to ensure sleep and recuperation. Regrettably, the noise pollution of our environment has greatly increased in the past. UNILUX offers the suitable glass for different noise sources - whether for buildings on busy roads or near discos and airports. UNILUX offers you high-quality glazing with improved sound insulation up to class 5, i.e. up to 45 dB (test value).



## [ Thermal insulation

These standard UNILUX glasses achieve insulation values that are by no means commonplace for windows. If that's not enough, you have the option to upgrade. You have the choice between SupraTherm, which achieves sensational insulation values. Or PrimaTherm 0.6 White - thanks to a new, invisible Low-e coating, you can use the energy from the sun's rays more effectively. More solar heat finds its way into the house. At the same time, this coating ensures that the cold stays outside.



## [ +Sun protection

Large window fronts bring brightness and atmosphere to our buildings. On the other hand, rooms can heat up quickly as the sun shines on the generous window panes. To counteract this, UNILUX offers you sun protection glasses. The sun protection glass has two functions: In summer, it reduces solar radiation and thus reduces the heating of the building. In cool weather, the glass acts as a thermal protection and saves energy. The rays of the sun are reflected or absorbed by the solar protection glass without darkening the room.

# Shades and screens

There are different options for protection from intensive sunlight and curious eyes. Whether classical roller shutter, elegant Venetian blinds, or traditional aluminum shutters, UNILUX offers you your individual shade and screen solution. By the way, we have a few good recipes against insects, too.



## Variety of bars & dividers

Divided lights are the icing on the cake when it comes to a window's appearance. Our range covers four different lines, from true divided and simulated divided lites to the astragal and georgian bar designs.

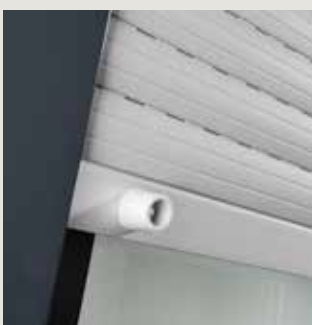

## Sunshades and more

At UNILUX, we have first-class roller shutters, and insect screens that are either built into the roller shutter box or act as a separate component.



## Lockability

Not every window needs to be opened, especially when there are small children around. That's why most of our handles come with a lock button, and are also available as lockable variants. Just in case.



## **[ Venetian blinds**

Blindingly bright or pitch dark? Venetian blinds give you many more nuances than that. They can control incoming light on a continuous basis. The strips, with their adjustable tilt, allow you to determine exactly how much sunlight you let into your rooms. And the Venetian blind also has an excellent visual appearance.

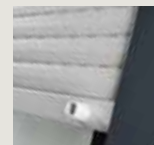

## **[ Roller shutter**

When it comes to blocking out light, roller shutters have been the benchmark forever. No wonder they're preferred for use in bedrooms. And since the box appearance is the same as for our venetian blinds, you can combine UNILUX roller shutters and Venetian blinds together harmoniously.

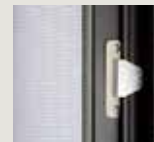

## **[ Insect protection**

It's not just in bedrooms that insects are a bother. Biting flies and wasps can rob your enjoyment of the fresh air. So you can still air out without the worries, there are special clamping frames and rotating doors. You can easily mount these insect screens yourself. Comfort is so easy.



**Venetian blinds**  
Top-mounted venetian shutter, made from polyurethane, with exterior inspection opening.



**Roller shutter**  
Top-mounted roller shutter, made from polyurethane, with exterior inspection opening.



**Roller shutter**  
Top-mounted roller shutter, made from polyurethane, with interior inspection opening.



UNILUX widens  
your perspectives

**Impressive  
glass surfaces.  
Slim profiles.**





For unlimited vision  
and new spheres of  
experience.





# Full-glass corner window OpenView

The dream which comes true. OpenView allows you to gaze far into the distance – without any interfering window frames in the corner. Uninterrupted views for as far as the eye can see.



## Technical masterpiece

While completely transparent, it conceals a sophisticated UNILUX construction. An invisible insulation is integrated into the assembly of stepped glazing, which effectively minimises the formation of condensation. The black stripe that characterizes the glass corner consists of high-quality enamel, which is optically refracted in the glass so that only a shadow gap is visible. Typically UNILUX - masterfully crafted down to the last detail.

## Freedom of design

Whether as a strip of tall windows or a large glass field, OpenView adds value to modern, high-quality architecture. Of course, this impressive structural feature comes in wood species, contours, wood colors and external colors which blend in perfectly with the UNILUX aluminum clad wood windows. It is also available with energy saving triple-pane glass, upon request.



### Slender profile

The filigree design enables maximum transparency. Aesthetics and robustness become one thanks to the safety glass.

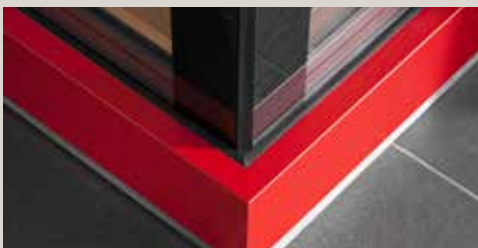
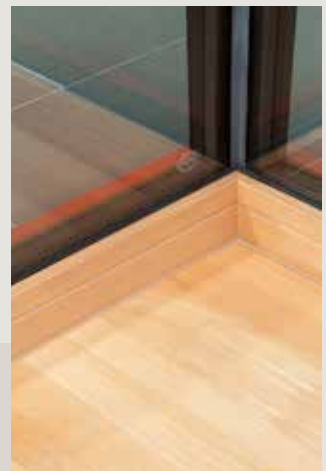

### Maximum performance

Namely, in terms of energy and architecture: The corner is joined via an assembly glass. This allows for an almost invisible insulation of the glass behind it.



### Safety glass

The standard tempered safety glass (with seal) ensures firmness and optimized load distribution.



# Lift/Slide system HS

The classic model in its most convenient form. With the lift/slide system, you'll see how sliding becomes gliding.

A simple panel movement creates an opening approximately 10' / 3 meter wide and 9' / 2.8 meter high.



## Exemplary craftsmanship

The lift/slide system perfectly demonstrates nature of UNILUX's products. High-quality hardware and solid constructions enable long-lasting elements which ensure maximum views and grand openings.

## Freedom of design

Easy on the eye: The lift -slide system comes in wood species, con-tours, wood colors and external colors which blend seamlessly into the UNILUX aluminum clad wood windows.



Installation depth	Glass thickness	U <sub>w</sub> -value	U <sub>g</sub> -value	Burglar-proofing	Soundproofing
213 mm	up to 52 mm	up to 0,78 W/m <sup>2</sup> K	up to 0,5 W/m <sup>2</sup> K	up to RC2	npd



### Low threshold

No stumbling, no stopping. Inside and outdoors join seamlessly. Freedom from barriers that's also visually attractive.



### A handle on everything

Thanks to a practical recess and solid handle, the panels can be easily moved both inside and outside. The system also comes in a lockable version.

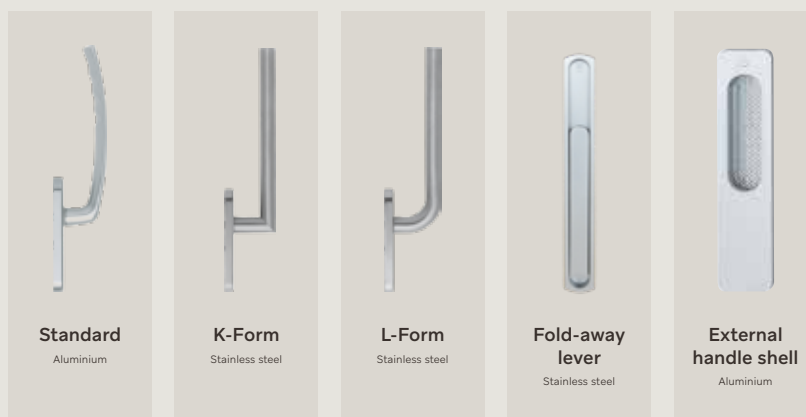

- |                                                                                                   |                                                                                                     |                                                                                                     |                                                                                            |                                                                                                      |
|---------------------------------------------------------------------------------------------------|-----------------------------------------------------------------------------------------------------|-----------------------------------------------------------------------------------------------------|--------------------------------------------------------------------------------------------|------------------------------------------------------------------------------------------------------|
|                |                  |                  |         |                 |
| <b>Standard</b><br>Aluminium                                                                      | <b>K-Form</b><br>Stainless steel                                                                    | <b>L-Form</b><br>Stainless steel                                                                    | <b>Fold-away lever</b><br>Stainless steel                                                  | <b>External handle shell</b><br>Aluminium                                                            |
|  silver        |  stainless steel |  stainless steel |  silver |  silver          |
|  steel colours |  black           |                                                                                                     |  bronze |  steel colours   |
|  bronze        |                                                                                                     |                                                                                                     |  white  |  bronze          |
|  white         |                                                                                                     |                                                                                                     |                                                                                            |  white           |
|                                                                                                   |                                                                                                     |                                                                                                     |                                                                                            |  black           |
|                                                                                                   |                                                                                                     |                                                                                                     |                                                                                            |  stainless steel |

### Common window profiles

Design from a single cast: Slim design to match the tilt-and-turn windows, as well as large selection of elegant handles made from a variety of materials in different colours.

To find out what handles are available in a certain colour, simply get in touch with your UNILUX specialist partner.



# Wood-aluminium slide-and-fold systems

There are no obstacles here. With our slide-and-fold systems, no need to move plants or floor lamps, because the door panels fold outwards, creating an opening up to 23'/7 meter wide and 9'/2.8 meter high. And a nice benefit: If you open the door after a rain shower, the water automatically drains to the outside – leaving everything dry inside.

## Exemplary durability

Our wood-aluminium slide-and-fold systems are a superb example of the solidity and robustness of UNILUX constructions. Aluminum is used as the base material and wood as the cladding, creating a high degree of rigidity in one element, in which everything fits perfectly together.



## Freedom of design

Easy on the eye: SFS (slide-and-fold systems) comes in wood species, contours, wood colors and external colors which blend seamlessly into the UNILUX aluminum clad wood window line (including energy saving triple-pane glass). Even the external handle can be matched to the unit's exterior color. And with Exterior, you can even get recessed thresholds on request.



Pic: Solarlux

### Handles

Practical when you want to get out quickly. Depending on how the elements are divided, a standard door handle can be installed.



Pic: Solarlux



Pic: Solarlux

### Freedom of interior design

As the panels open outwards, you don't need to create any space for them inside. And when they are opened, raindrops land on the terrace instead of the floor.

### Seamless connection

Depending on the architecture, the panels' castors can be integrated into the floor – forming the basis for a flat sill track and fluid transition.





### Exemplary strength

UNILUX only uses solid, laminated wood protected by a weather-proof aluminum cladding, which also holds the glass panes in place. These robust materials, as well as the sophisticated, invisible connection technology for posts and beams, ensure maximum stability even for large façades extending beyond one floor.

### Freedom of design

Easy on the eye: The large glass areas enable personalized interior design. The slender, elegant FineLine façade comes in a variety of wood species and colors, contours and aluminum exterior colors, which blend seamlessly into the UNILUX aluminum clad wood window lines. Available with energy saving triple-pane glass, upon request.



# Facade system (Curtain Wall) FineLine

The name's the game. FineLine is distinguished by its slender yet solid post & beam construction. The sophisticated connection technology allows even tricky architectural tasks to be mastered with maximum quality.



## Energy efficiency

Optimum U-value according to passive house standards is achieved, thanks to the thermally insulated construction. The heat stays in and the cold stays out.

## Aesthetics

Solid wood, perfectly presented. The base connection with post-and-beam profile is just one example of the importance UNILUX places on high-quality architectural solutions.

## Workmanship

Closer inspection please. Examining details reveals just how much precision work goes into each UNILUX product.



# Large-scale door

# JumboLine

High window elements are increasingly popular. It's good when balcony doors can keep up. While the standard balcony door gives out after 2.60 meters (8'-6"), our JumboLine balcony doors can manage heights of up to 3 meters (10'). The key are the massive power hinges, which can manage loads of up to 300 kilograms.



## Harmony in completion

Engineering and aesthetics make a harmonious couple. For example, the sash limiter which prevents the panel from excessive opening is only visible when the door opens. The structural glass and securely anchored hardware ensure maximum stability – the panel is easy to operate even after many years.



## Seamless integration

The JumboLine is available in all the aluminum clad designs, aluminum colors, wood species and finishes of the standard aluminum clad wood windows.



Pic. 4

### Multiple locking

As an option for standard locking (see p. 21), we offer two multiple-locking versions for balcony doors. Multiple locking systems consist of a main lock, additional locking systems and the frame parts. This provides even greater convenience when opening and closing.

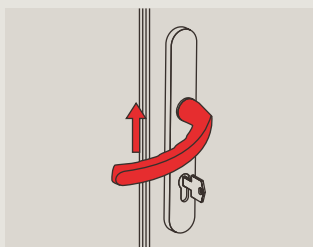

#### - Lever handle-actuated

Simple, safe, convenient: On the additional MFVDB lever handle-actuated locking system, the door handle itself actuates the additional locking system. The user can also lock the door with a key if required.

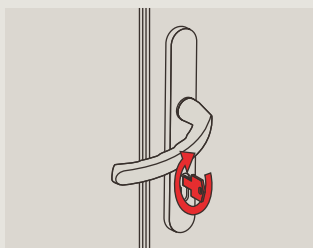

#### - Cylinder-actuated

For extra security: On the additional MFVZB cylinder-actuated multiple locking system, the door is actuated via the lock cylinder of the main lock.



Pic. 5



### Filigree profiles

The door may be tall and heavy, but its panels are just as slim as any of our elegant tilt-and-turn windows.



### Invisible sash limiter

To protect the hinges, standard Jumbo-Lines have a build-in, invisible turn restrictor which automatically stops the door from opening beyond a 90° angle.

### Strong hardware

Thanks to solid door hinges, even heavy panels (as a standard up to 385 lbs/175 kg, with PowerHinge up to 660 lbs/300 kg) are a piece of cake for this large door. And a durable construction ensures long-lasting use.



# References



Pic: 1



Pic: 3

Pic: 8





# The reliability of a big name

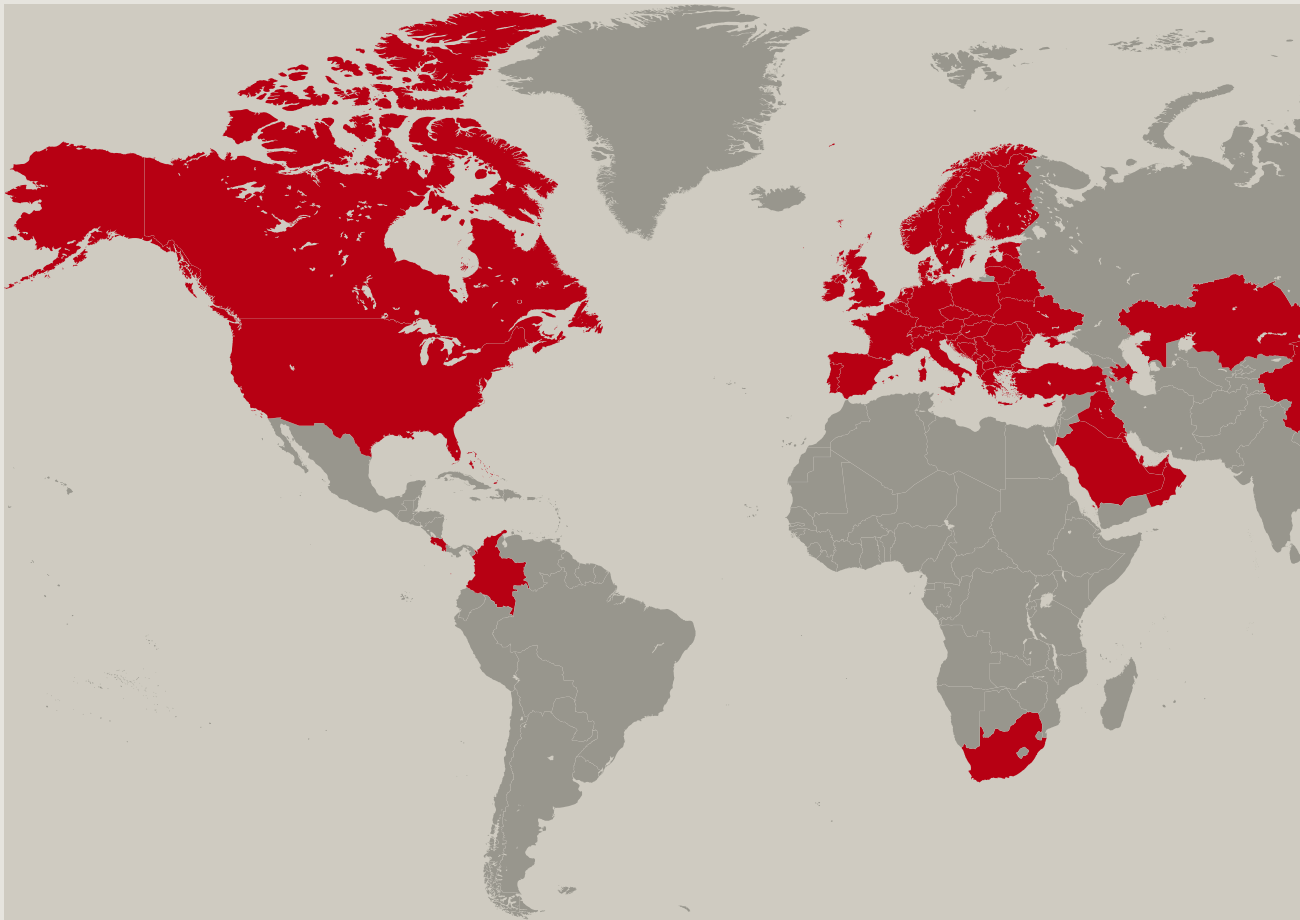

UNILUX ensures award-winning long-term progress - by selecting the right partners and raw-material suppliers, and by being a member of leading institutions and associations:



UNILUX products meet international test and safety standards:



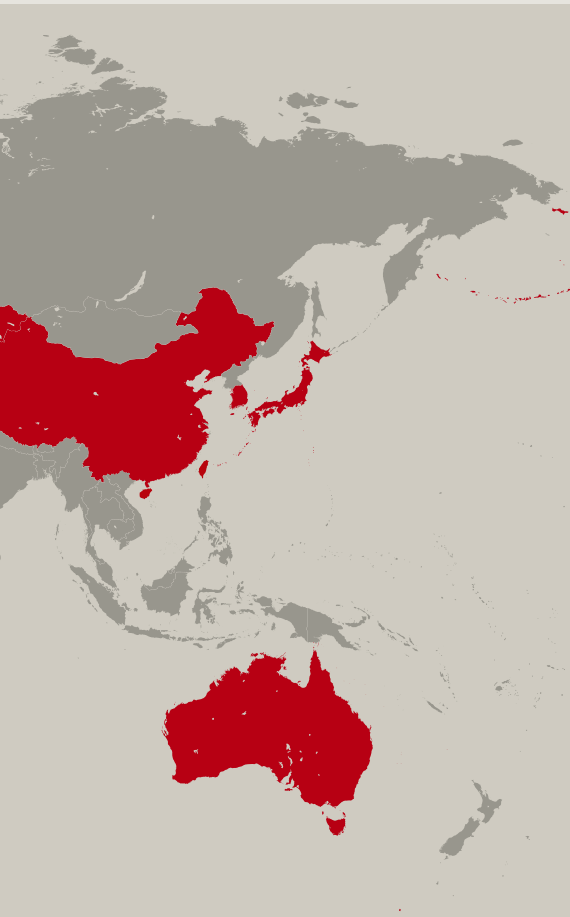

## Company info

### Publisher

UNILUX GmbH

54528 Salmtal / Germany

Phone +49 6578 189-0

Fax +49 6578 188-0

[info@unilux.de](mailto:info@unilux.de)

[www.unilux.de](http://www.unilux.de)

### Notes

The content of this catalogue is not legally binding and may be subject to technical changes as part of further developments or errors in the text, images or descriptions. We only allow images and text material – including excerpts – to be used upon request, and with our express written consent.

The image material used is for illustrative purposes. Differences in color are unfortunately unavoidable due to printing. The sample illustrations are not to scale.

© 2026, UNILUX GmbH. All rights reserved.



UNILUX headquarter, Salmtal

Photos: UNILUX, iStockphoto, Fotolia, Shutterstock

Pic 1: Architekturbüro Johannes Kraus, AU 1070 Wien, Architekturbüro Broß – Kurzenberger, 21DE 79100 Freiburg | Pic 2: Architekturbüro Richard Stihler, DE 77933 Lahr | Pic 3: Architekturbüro Hänggi, CH 4144 Arlesheim | Pic 4: OMP Gruppe Architektengesellschaft, DE 26180 Rastede | Pic 5: POP Fassadenberatung, DE 28876 Oyten | Pic 6: UNILUX | Pic 7: Architekten BBO, DE 33647 Bielefeld | Pic 8: Kaufmann und Schneider, DE 10585 Berlin | Pic 9: Kindergarten, AU 8583 Edelschrott | Pic 10: Stilewood, Port Coquitlam, BC, V3C 1S5 Canada | Pic 11: Architekturbüro Raymond Küfner, DE 91126 Schwabach | Pic 12: ProZent GmbH, DE 46537 Dinslaken | Pic 13: aib-Bauplanung Nord GmbH, Ramona Hanisch, Rostock | Pic 14: MiguelBabo Photography, Freiburg | Cover: Architekturbüro Johannes Kraus, AU 1070 Wien, Architekturbüro Broß – Kurzenberger, DE 79100 Freiburg

# Contact:

Phone: +49 (0) 6578 189-0

E-Mail: [info@unilux.de](mailto:info@unilux.de)

Further information on products can  
be found at: [www.unilux.de](http://www.unilux.de)